

NSE 3 V2A (490 003)

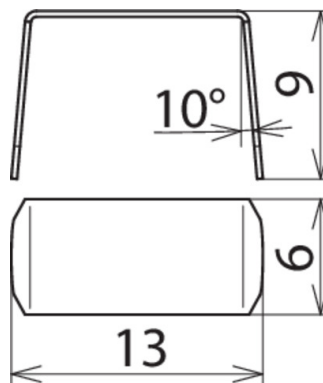

Figure without obligation

Type	NSE 3 V2A
Part No.	490 003
Material	StSt
Number	3
Weight	0 g
Customs tariff number (Comb. Nomenclature EU)	83100000
GTIN	4013364306509
PU	100 pc(s)

We reserve the right to introduce changes in performance, configuration and technology, dimensions, weights and materials in the course of technical progress. The figures are shown without obligation.

Any other numbering or labelling of the number plates available upon request!